

## Modèles à refoulement horizontal fileté et bridé [GAZ 2" - DN50 PN10-16] - 2 pôles

### Performances

	l/s	0	2	4	6	8	10
	l/min	0	120	240	360	480	600
	m³/h	0	7.2	14.4	21.6	28.8	36.0
① DGE 50/2/G50H A1BM[T]5			5.3	3.4	1.0		
② DGE 75/2/G50H A1BM[T]5			6.3	4.3	2.2		
③ DGE 100/2/G50H A0CM[T]5			10.2	7.8	5.3	2.8	
④ DGE 150/2/G50H A0CM[T]5			11.9	9.8	7.5	5.1	2.7
⑤ DGE 200/2/G50H A0CM[T]5			13.2	10.8	8.3	6.0	3.7

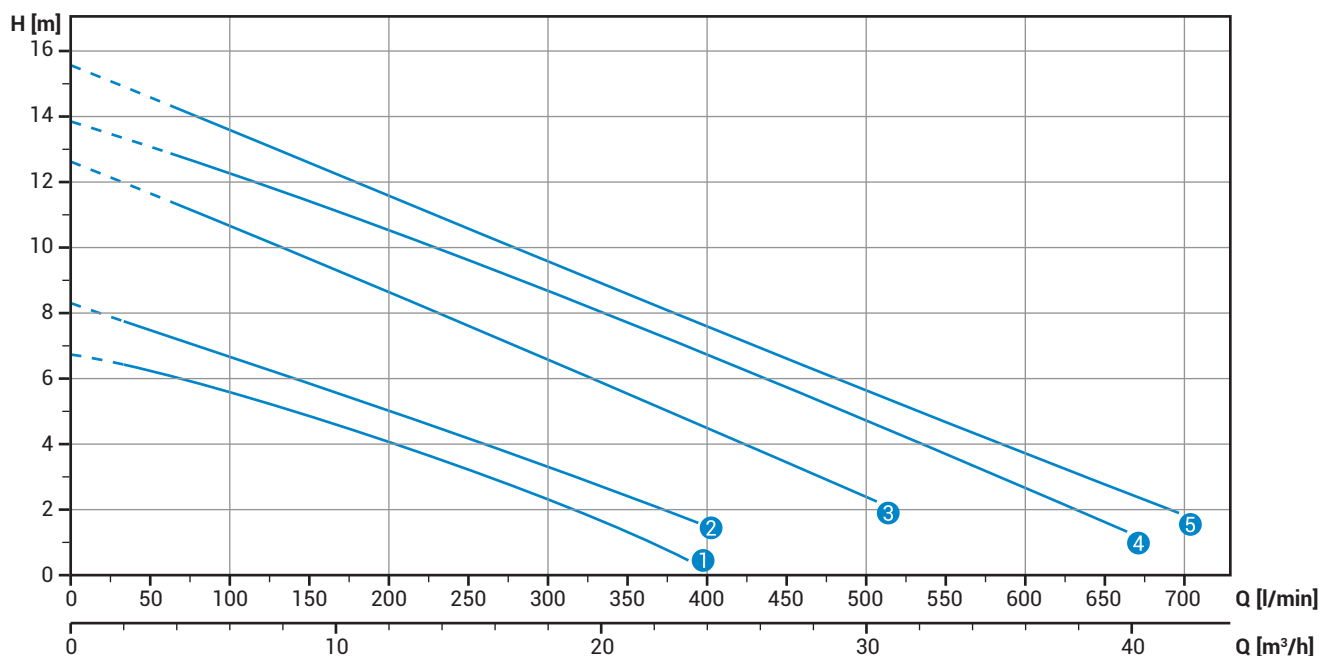

### Données techniques

	V	Phases	P1 [kw]	P2 [kw]	A	Rpm	Ø	Passage libre
① DGE 50/2/G50H A1BM5	230	1	-	0.37	2.8	2900	G 2"- DN50 PN10-16	35 mm
② DGE 75/2/G50H A1BM5	230	1	-	0.55	3.6	2900	G 2"- DN50 PN10-16	35 mm
③ DGE 100/2/G50H A0CM5	230	1	-	0.88	6.5	2900	G 2"- DN50 PN10-16	50 mm
④ DGE 150/2/G50H A0CM5	230	1	-	1.10	8.2	2900	G 2"- DN50 PN10-16	50 mm
⑤ DGE 200/2/G50H A0CM5	230	1	-	1.50	9.4	2900	G 2"- DN50 PN10-16	50 mm
① DGE 50/2/G50H A1BT5	400	3	-	0.37	1.1	2900	G 2"- DN50 PN10-16	35 mm
② DGE 75/2/G50H A1BT5	400	3	-	0.55	1.3	2900	G 2"- DN50 PN10-16	35 mm
③ DGE 100/2/G50H A0CT5	400	3	-	0.88	2.2	2900	G 2"- DN50 PN10-16	50 mm
④ DGE 150/2/G50H A0CT5	400	3	-	1.10	2.6	2900	G 2"- DN50 PN10-16	50 mm
⑤ DGE 200/2/G50H A0CT5	400	3	-	1.50	3.6	2900	G 2"- DN50 PN10-16	50 mm

## Dimensions

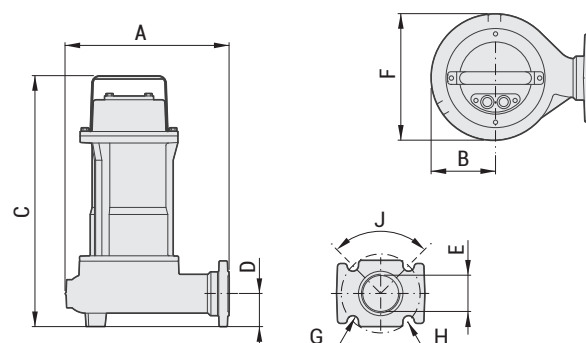

	Dimensions d'encombrement (mm)									kg	X Y Z		
	A	B	C	D	E	F	G	H	J		X	Y	Z
DGE 100/2/G40V A0CM[T]5	260	100	405	125	GAS 1 1/2"	205	-	-	-	19	285	475	235
DGE 150/2/G40V A0CM[T]5	260	100	405	125	GAS 1 1/2"	205	-	-	-	20	285	475	235
DGE 200/2/G40V A0CM[T]5	260	100	405	125	GAS 1 1/2"	205	-	-	-	21	285	475	235
DGE 50/2/G50V B0BM[T]5	230	80	385	120	GAS 2"	165	-	-	-	12	225	385	245
DGE 75/2/G50V B0BM[T]5	230	80	385	120	GAS 2"	165	-	-	-	14	225	385	245
DGE 100/2/G50V B0CM[T]5	270	100	100	130	GAS 2"	205	-	-	-	19	285	475	235
DGE 150/2/G50V B0CM[T]5	270	100	100	130	GAS 2"	205	-	-	-	20	285	475	235
DGE 200/2/G50V B0CM[T]5	270	100	100	150	GAS 2"	205	-	-	-	21	285	475	235
DGE 50/2/G50H A1BM[T]5	220	80	365	65	GAS 2" - DN50	160	18	125	90°	12	225	385	245
DGE 75/2/G50H A1BM[T]5	220	80	365	65	GAS 2" - DN50	160	18	125	90°	14	225	385	245
DGE 100/2/G50H A0CM[T]5	260	100	430	80	GAS 2" - DN50	205	18	125	90°	19	285	475	235
DGE 150/2/G50H A0CM[T]5	260	100	430	80	GAS 2" - DN50	205	18	125	90°	20	285	475	235
DGE 200/2/G50H A0CM[T]5	260	100	430	80	GAS 2" - DN50	205	18	125	90°	21	285	475	235

## Versions

### Modèles monophasés

- TC Protection thermique, condensateur
- TCG Protection thermique, condensateur, flotteur

### Modèles triphasés

- NAE Aucun accessoire électrique
- TRG Protection thermique, relais, flotteur

## Installations

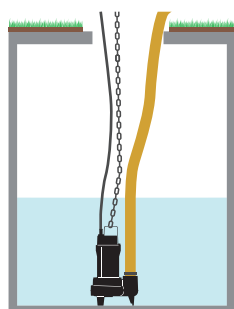

MOBILE

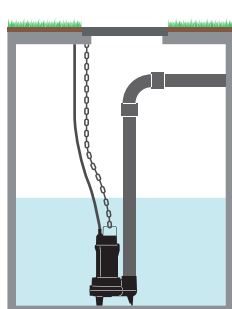

FIXE

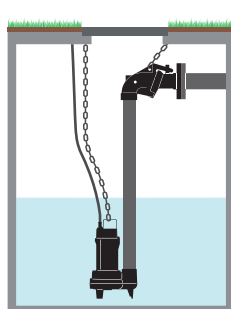

AVEC DISPOSITIF  
D'ACCOUPLMENT EXTERNE  
[DAC-E - Page 78]

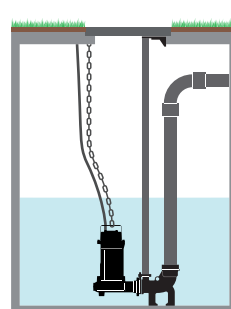

AVEC DISPOSITIF D'ACCOUPLMENT AU FOND  
[DAC-V - Page 79]

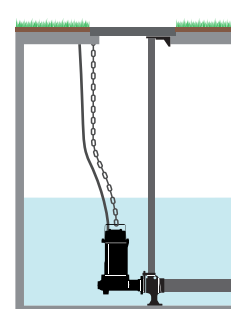

[DAC-H - Page 80]